

Drill Table

Hole Dia (inch)	Symbol	Quantity	Plated
0.016	+	141	Yes
0.034	X	14	Yes
0.038	Y	104	Yes
0.046	T	3	Yes
0.062	Z	2	Yes
0.068	M	9	Yes
0.094	Q	8	Yes
0.120	D	9	Yes
0.125	S	6	Yes

Material: FR-4 .062" 94V-0
 Mask: LP, Green, Both sides
 Silkscreen: White Ink

DRILL GUIDE

Title			LED Display Digitizer		
Size	Number		Rev		
Date	Tue Aug 18, 2009		DIGIT		A
Filename	DIGITA16.PCB		Sheet		of

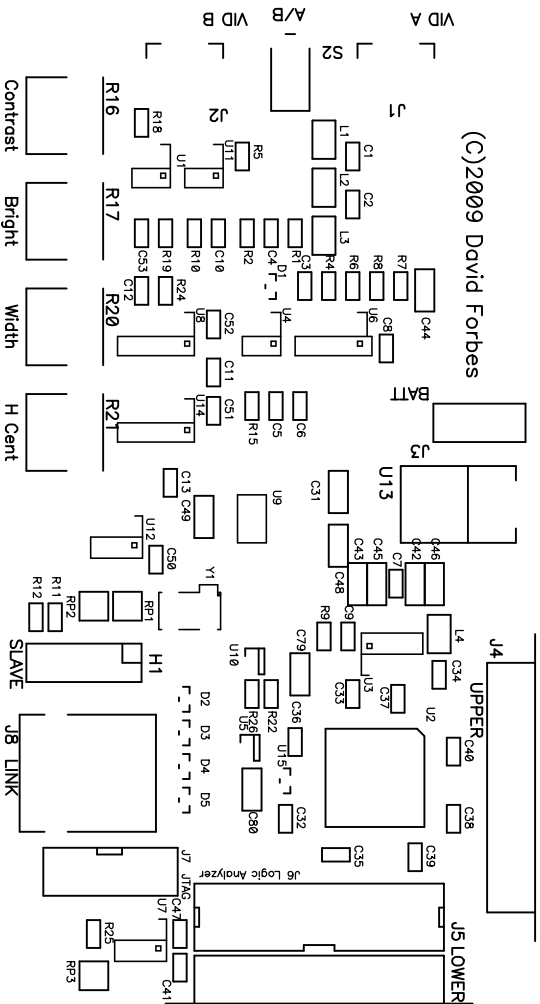

TOP SILK SCREEN

Title		LED Display Digitizer	
Size	Number	DIGIT	Rev A
Date	Tue Aug 18, 2009	Drawn by David Forbes	
Filename	DIGITA16.PCB	Sheet	of

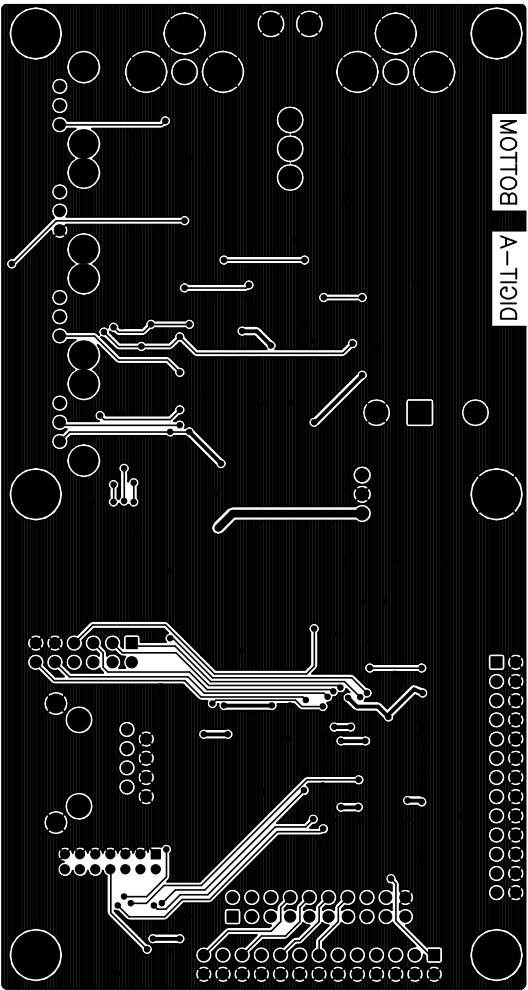

BOTTOM SIDE

Title		LED Display Digitizer	
Size	Number	DIGIT	Rev A
Date	Tue Aug 18, 2009	Drawn by David Forbes	
Filename	DIGITA16.PCB	Sheet	of

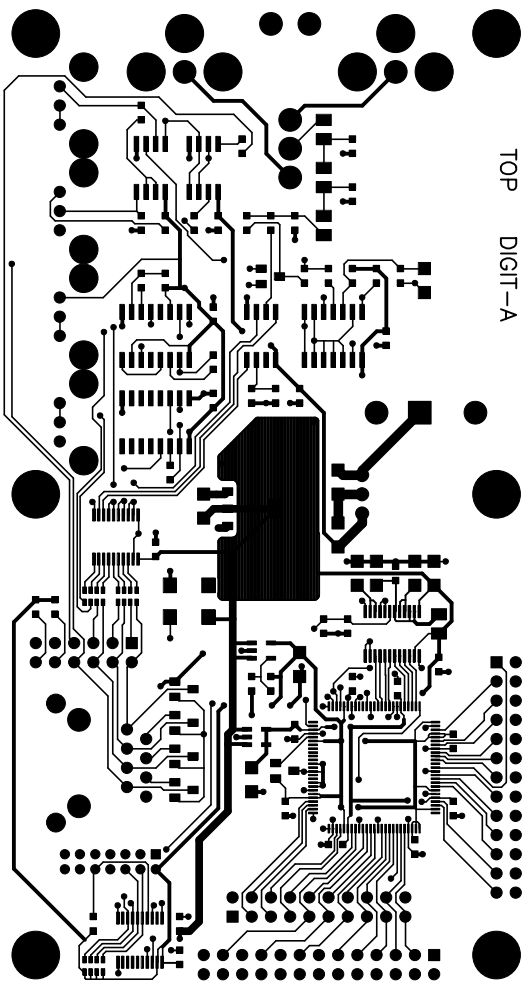

TOP SIDE

Title		LED Display Digitizer	
Size	Number	DIGIT	Rev A
Date	Tue Aug 18, 2009		
Filename	DIGITA16.PCB	Sheet	of

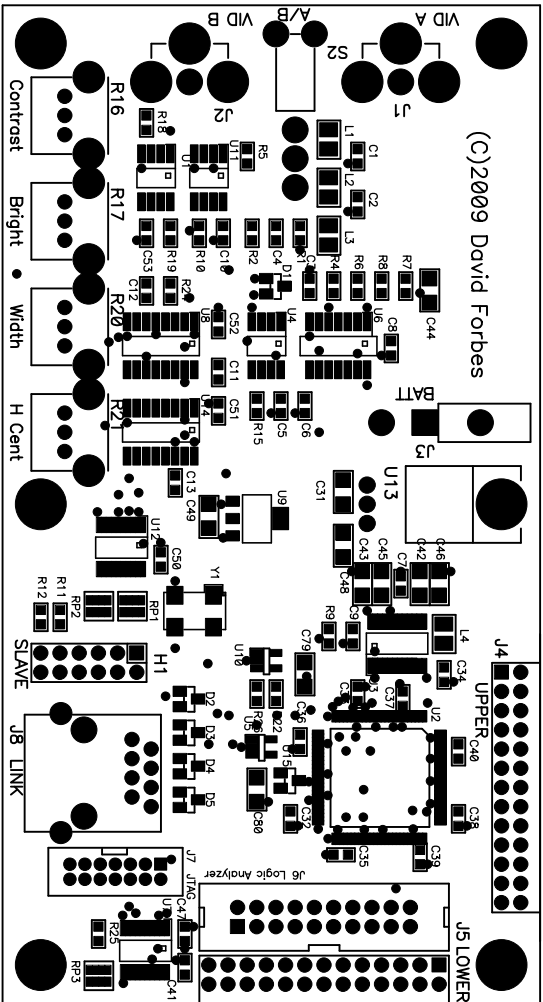

TOP SILK SCREEN
TOP MASK

Title		LED Display Digitizer	
Size	Number	DIGIT	Rev A
Date	Tue Aug 18, 2009	Drawn by David Forbes	
Filename	DIGITA16.PCB	Sheet	of

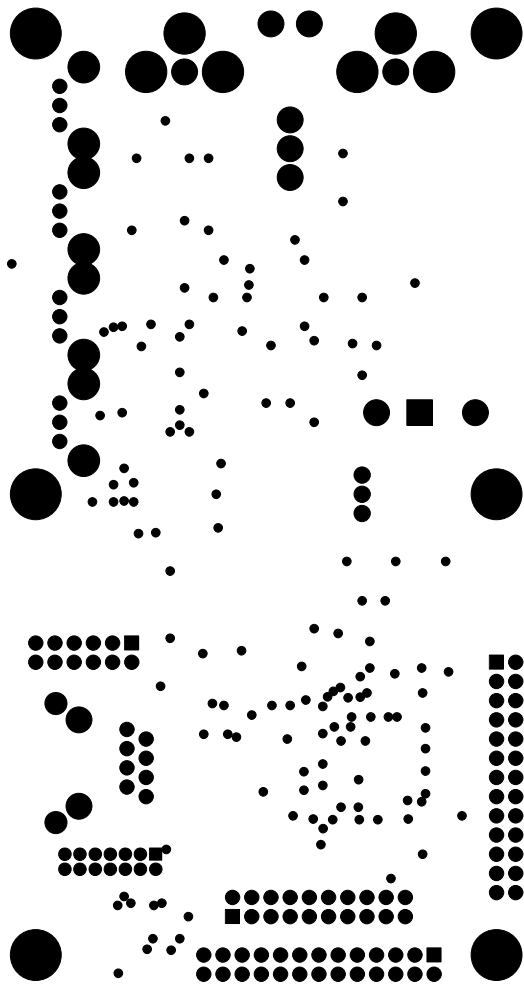

BOTTOM MASK

Title		LED Display Digitizer	
Size	Number	DIGIT	Rev A
Date	Tue Aug 18, 2009	Drawn by David Forbes	
Filename	DIGITA16.PCB	Sheet	of

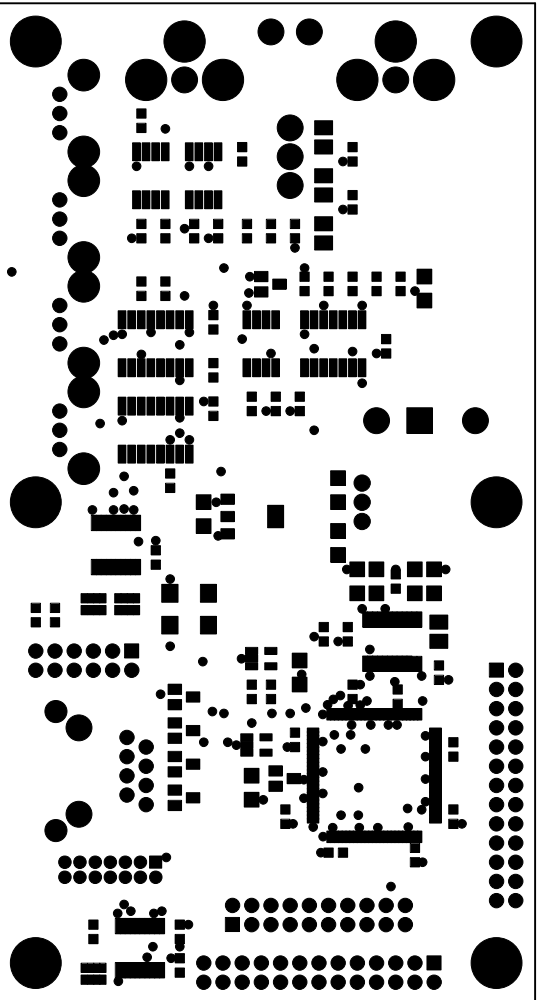

TOP MASK

Title		LED Display Digitizer	
Size	Number	DIGIT	Rev A
Date	Tue Aug 18, 2009	Drawn by David Forbes	
Filename	DIGITA16.PCB	Sheet	of

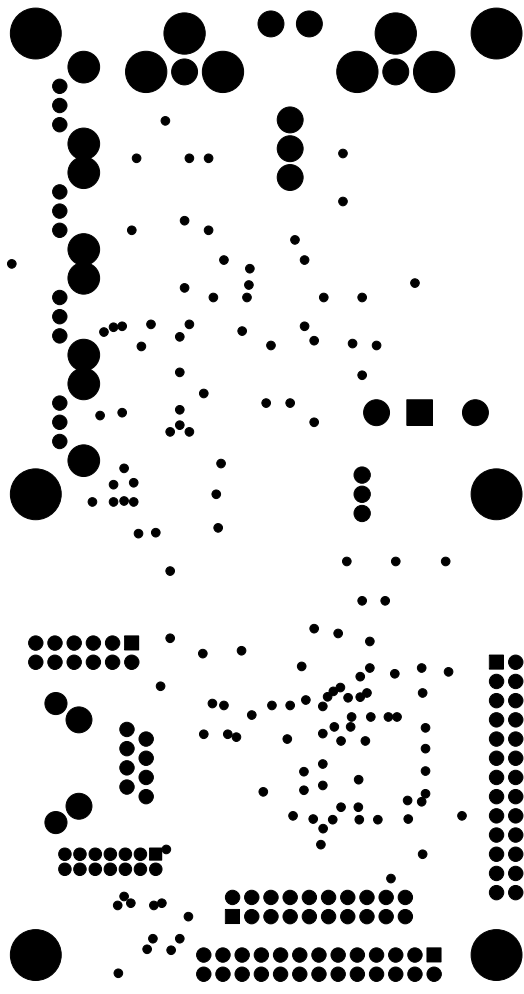

BOTTOM MASK

Title		LED Display Digitizer	
Size	Number	DIGIT	Rev A
Date	Tue Aug 18, 2009	Drawn by David Forbes	
Filename	DIGITA16.PCB	Sheet	of